

Produktenerweiterung / Product extension

miniTURN™ Solid Carbide















Wirtschaftliche Zerspanung von kleinen Bauteilen
Economical machining of small components







ZCC Cutting Tools Europe GmbH

your Partner | your Value

Content - Inhaltsverzeichnis - Werkzeuge / Tools

Serie	Typ Type	Beschreibung Description	Anwendung Application	Seite Page
T1		mit Eckenradius ohne Spanformer <i>with corner radius, without chip breaker</i>		8
T2	Ausdrehen und Kopieren	mit Eckenradius, ohne Spanformer, stirnseitig 0° <i>with corner radius, without chip breaker, front side 0°</i>		9
T3	Turning and Profiling	mit Eckenradius, 47° Freiwinkel <i>with corner radius, 47° clearance angle</i>		10
T4		mit Eckenradius, stirnseitig 20° <i>with corner radius, front side 20°</i>		11
C1	Fasen Chamfering	mit Eckenradius, 45° Fase <i>with corner radius, 45° chamfer</i>		12
B1	Rückwärtsbearbeitung Back Turning	mit Eckenradius, 45° Fase <i>with corner radius, 45° chamfer</i>		13
G1	Stechen und Drehen Grooving and Profiling	Stechen mit & ohne Eckenradius <i>Grooving with & without corner radius</i>		14
G2		Stechdrehen & Kopieren mit Vollradius <i>Grooving & Profiling with full radius</i>		16
P1	Gewindedrehen Threading	Teilprofil 60° <i>Partial profile 60°</i>		17
P2		metr. ISO Regel- & Feingewinde Vollprofil 60° <i>ISO metric & fine thread full profile 60°</i>		18
P3		Teilprofil 55° <i>Partial profile 55°</i>		19
P4		Whitworth-Gewinde Vollprofil 55° <i>Whitworth-Thread full profile 55°</i>		20
F1		mit Eckenradius, innen <i>with corner radius, internal</i>		21
F2	Axial-Stechen Face Grooving	mit Eckenradius, für die Zapfenbearbeitung <i>with corner radius, for pivots application</i>		22
F3		mit und ohne Eckenradius, <i>with and without corner radius</i>		23

Content - Inhaltsverzeichnis - Halter / Holder

Serie	Typ Type	Beschreibung Description	Anwendung Application	Seite Page
DH	Klemmhalter mit IK <i>Toolholder with internal coolant</i>	Halter doppelseitig <i>Double sided holder</i>		25
SH		Halter einseitig <i>single sided holder</i>		26
QH	Klemmhalter ohne IK <i>Toolholder without internal coolant</i>	Quadratischer Stechhalter <i>Square grooving holder</i>		27
QH90		Quadratischer Stechhalter 90° <i>Square grooving holder 90°</i>		27
QHU	Universal Klemmhalter <i>Universal toolholder</i>	Quadratischer universal Stechhalter <i>Universal square grooving holder</i>		28

miniTURN *Solid Carbide*

Wirtschaftliche Zerspantung von hochpräzisen Innenbearbeitungen ab 1mm Ø Bearbeitungsdurchmesser.
 Economical machining of high-precision internal applications from diameter 1mm.



Scharfes Schneidkantendesign sorgt für höhere Schnittigkeit bei **geringem Schnittdruck**, somit erreichen wir die **höchste Präzision**.

Sharp cutting edge design ensures higher cutting performance with low cutting pressure, thus achieving the highest precision.

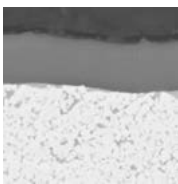

YPG201

Perfekt ausgerichteter Beschichtungsprozess mit **Optimaler Schichthftung** sorgt für maximale Standzeit.

*Perfectly aligned coating process with **optimum layer adhesion** ensures maximum service life.*

Die **super glatte Beschichtungsfläche** erhöht die Gleiteigenschaft erheblich, somit erreichen wir einen **geringen Wärmeintrag** ins Werkzeug. Ausgewogene Härte und Eigenspannungsverhältnis bieten ein **großes Anwendungsspektrum**.

*The **super smooth coating** surface increases significantly the sliding properties, so we achieve a **low heat input** into the tool.*

*Balanced hardness and internal stress offer a **wide range** of applications.*

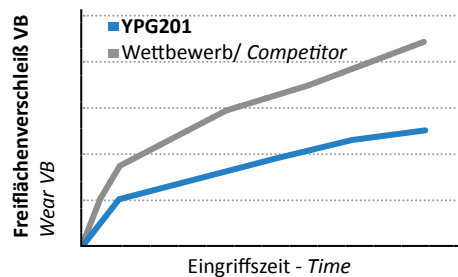
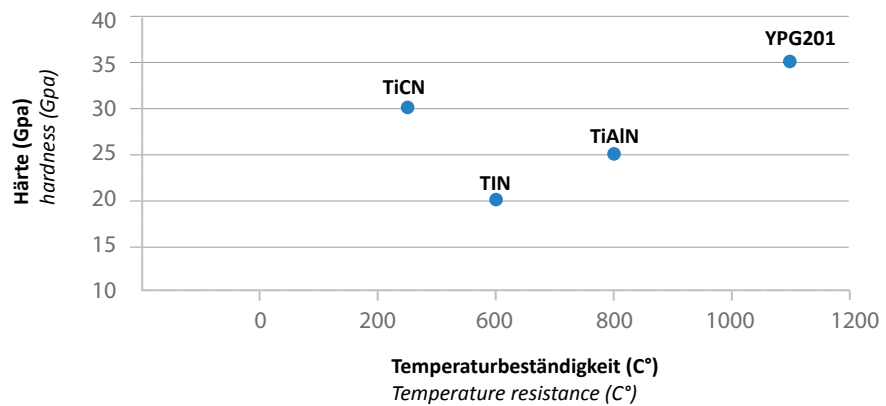

Ausgiebige Versuchsreihen und Kundenfeedbacks bestätigen das wir hier in der High Performance Liga mitspielen. Mit Wiederholgenauigkeit und Standzeiterhöhungen heben wir uns aktuell vom Wettbewerb ab.

Extensive test series and customer feedback confirm that we are playing in the High Performance League. With repeatability and tool life increases, we stand to date from the competition.



Plug and Play System

Einfache Handhabung mit hoher Wiederholgenauigkeit!
Easy handling with high repeat accuracy!

- ✓ Über Anschlagstift und Schnittstelle erreichen wir eine exakte Positionierung des Einsatzes, sodass dieser schnell und sicher in der Maschine gewechselt werden kann.
 - ✓ Die 3 Spannflächen am Halter sorgen für eine nahe zu beliebige Einbaurichtung.
 - ✓ Die SH –Serie lässt sich einfach über das 1/8“ Gewinde an das Kühlmittelsystem anschließen.
-
- ✓ *Due stop pin and the interface, we achieve an exact positioning of the insert, so that it can be changed quickly and safely in the machine.*
 - ✓ *The 3 clamping surfaces on the holder ensure almost any installation direction.*
 - ✓ *The SH series can be easily connected to the coolant system via the 1/8 „thread.*

Erklärung der Parameter und Kurzzeichen Explanation of the parameters and symbols

Kurzz. symbol	Einheit unit	Erklärung – Explanation
D_{h6}	mm	Schaftdurchmesser <i>shank diameter</i>
D_{min}		min. Bohrungsdurchmesser <i>min. bore diameter</i>
d_1		1. Bohrungsdurchmesser (Halter) <i>1st bore diameter (holder)</i>
d_2		2. Bohrungsdurchmesser (Halter) optional <i>2nd bore diameter (holder) option</i>
L		Gesamtlänge <i>total length</i>
L_1		Nutzlänge <i>effective length</i>
L_H		Länge bis Halter <i>length to holder</i>
R		Radius <i>radius</i>
t_{max}		max. Schnitttiefe <i>max. depth of cut</i>
H_1		Gewindetiefe <i>depth of thread</i>
H_p		Profilhöhe <i>profile height</i>
r		Kopfradius <i>tip radius</i>
w		Schnittbreite <i>width of cut</i>
a		Abstand Schneidkante bis Außenkontur <i>distance cutting edge to the outer contour</i>
f		Abstand Schneidkante bis Werkzeugmitte <i>distance cutting edge to the center of the tool</i>
d		Querschnitt Werkzeughals <i>cross-section tool neck</i>
P	Steigung <i>pitch</i>	
TPI	Gang Zoll	
R/L	Ausrichtung Direction	

Montiertes Drehwerkzeug
 Mounted tool

Empfohlener Anzugsmoment 1,1 Nm
 Recommended torque 1,1 Nm

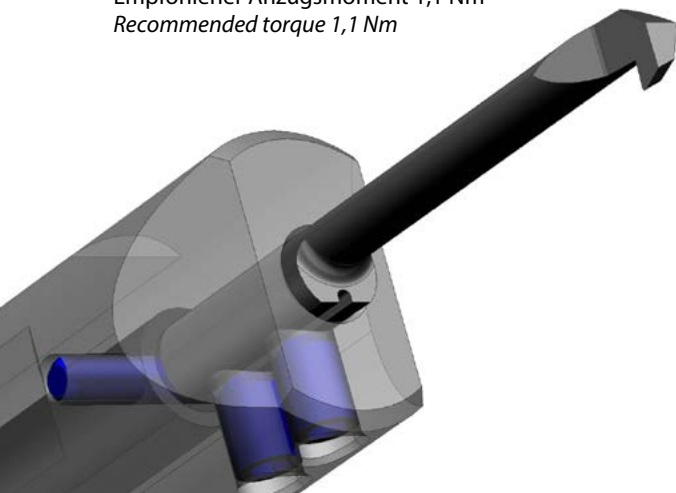

SH 1600 06

1 2 3 4

Typ	
Code	Beschreibung
DH	Halter doppelseitig
SH	Halter einseitig
QH	Quadratischer Stechhalter
QH 90	Quadratischer Stechhalter 90°
QHU	Universal Halter
RS	Reduzierhülse

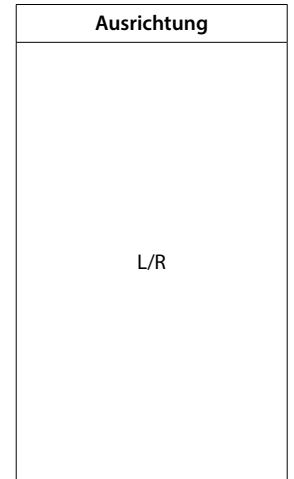
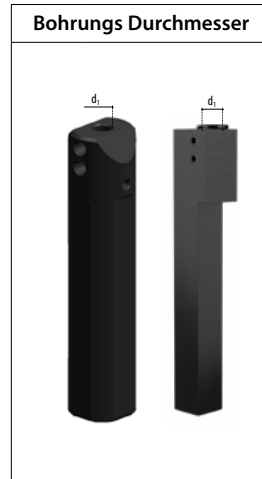

1

2

3

4

T1 4 10 04 008 R YPG201

1 2 3 4 5 6 7 8 9

Typ	
F1-F3	Axial- Stechen
F1	mit Eckenradius, innen
F2	mit Eckenradius, für die Zapfenbearbeitung
F3	mit und ohne Eckenradius
T1-T4	Drehen
T1	mit Eckenradius ohne Spanformer
T2	mit Eckenradius, ohne Spanformer, stirnseitig 0°
T3	mit Eckenradius, 47° Freiwinkel
T4	mit Eckenradius, stirnseitig 20°
C1	Fasen mit Eckenradius und 45° Fase
B1	Rückwärtsbearbeitung mit Eckenradius
G1-G2	Stechdrehen
G1	Stechen mit und ohne Eckenradius
G2	Stechdrehen und Kopieren mit Vollradius
P1-P4	Gewinde
P1	Teilprofil 60°
P2	metr. ISO Regel- und Feingewinde Vollprofil 60°
P3	Teilprofil 55°
P4	Whitworth-Gewinde Vollprofil 55°
X	Sonder

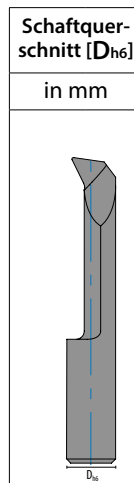

2

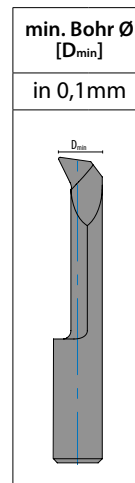

3

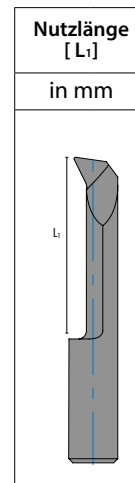

4

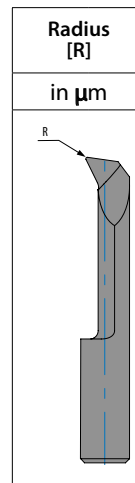

5

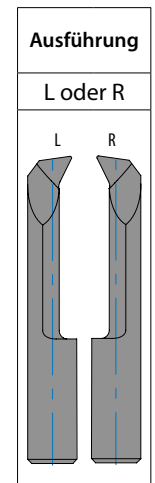

7

Stechbreite
in 0,1 mm
Steigung Gewinde metrisch
Gewinde Zoll
Teilprofil
P601 - 60° / 0,5-0,7 mm / 48-36 TPI
P602 - 60° / 0,5-1,0 mm / 48-24 TPI
P603 - 60° / 1,0-1,5 mm / 24-16 TPI
P551 - 55° / 28-18 TPI
P552 - 55° / 24-16 TPI

6

Sonder
Nur bei Sonderwerkzeugen

8



Sorte

9

1

SH 1600 06

1 2 3 4

Type		Shank Square Section	Bore Diameter	Direction
Code	Description	Holder		
DH	Double sided holder			L/R
SH	single sided holder			
QH	Square grooving holder			
QH 90	Square grooving holder 90°			
QHU	Universal toolholder			
RS	Reducing sleeve			

T1 4 10 04 008 R YPG201

1 2 3 4 5 6 7 8 9

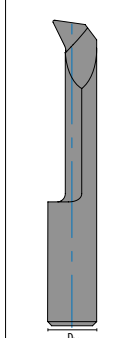
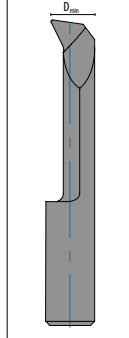
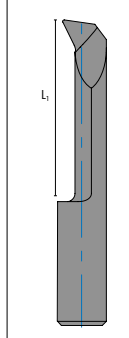
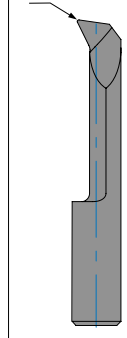
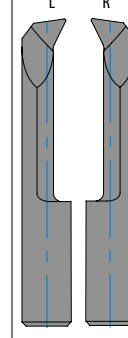
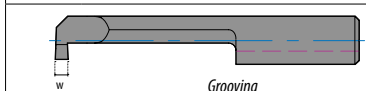
Type	Shank Square Section [D _{h6}]	Min Bore Ø [D _{min}]	effective length [L _i]	Radius [R]	Hand of Tool
	in mm	in 0,1mm	in mm	in µm	L or R
F1-F3 Face Grooving					
F1 with corner radius, internal					
F2 with corner radius, for pivots application					
F3 with and without toolholder					
T1-T4 Turning					
T1 with corner radius, without chip breaker					
T2 with corner radius, without chip breaker, front side 0°					
T3 with corner radius, 47° clearance angle					
T4 with corner radius, front side 20°					
C1 Chamfering with corner radius and 45° chamfer					
B1 Backturning with corner radius					
G1-G2 Grooving	Width of Cut in 0,1 mm			Special Only for special tools	
G1 Grooving with and without corner radius	Pitch threading metric			8	
G2 Grooving and Profiling with full radius	Threads per Inch threading inch Partial profile: P601 - 60° / 0,5-0,7 mm / 48-36 TPI P602 - 60° / 0,5-1,0 mm / 48-24 TPI P603 - 60° / 1,0-1,5 mm / 24-16 TPI P551 - 55° / 28-18 TPI P552 - 55° / 24-16 TPI				
P1-P4 Threading					
P1 Teilprofil 60°					
P2 metr. ISO Regel- und Feingewinde Vollprofil 60°				Grade	
P3 Partial profile 55°					
P4 Whitworth-Thread full profil 55°					
X Special					

Ausdrehen und Kopieren - Turning and Profiling

mit Eckenradius, ohne Spanbrecher - with corner radius, without chip breaker

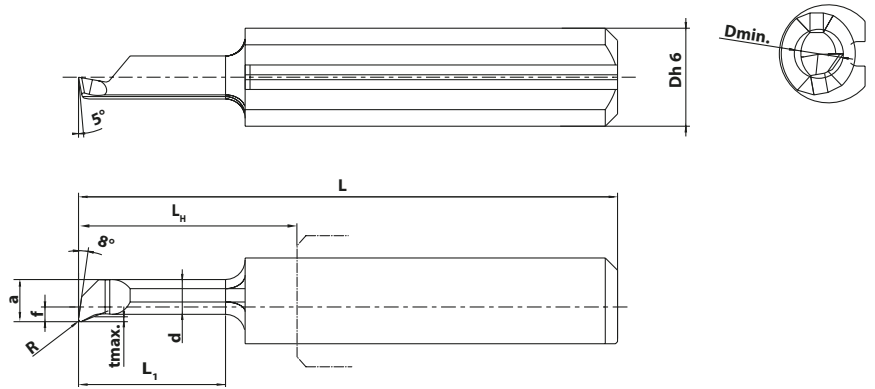
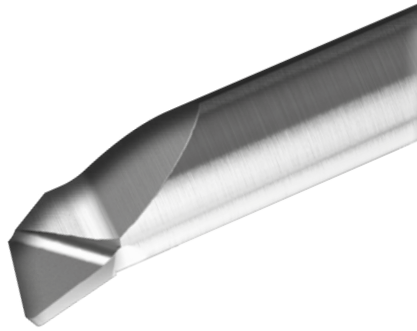

Abmessungen / Dimensions [mm]

Artikel /Article	Dh6	Dmin	L1	LH	L	R	tmax	a	f	d	HC ¹ (PVD)
											YPG201
T1.4.10.04.008L/R	4	1	4	6	20	0,08	0,1	0,9	0,6	0,7	●
T1.4.10.06.008L/R	4	1	6	8	22	0,08	0,1	0,9	0,6	0,7	●
T1.4.10.08.008L/R	4	1	8	10	24	0,08	0,1	0,9	0,6	0,7	●
T1.4.20.06.010L/R	4	2	6	8	22	0,10	0,2	1,7	0,6	1,4	●
T1.4.20.11.010L/R	4	2	11	13	27	0,10	0,2	1,7	0,6	1,4	●
T1.4.30.11.015L/R	4	3	11	13	27	0,15	0,25	2,75	0,75	2,4	●
T1.4.30.16.015L/R	4	3	16	18	32	0,15	0,25	2,75	0,75	2,4	●
T1.4.30.21.015L/R	4	3	21	23	37	0,15	0,25	2,75	0,75	2,4	●
T1.4.40.11.005L/R	4	4	11	13	27	0,05	0,3	3,7	1,7	3,3	●
T1.4.40.16.005L/R	4	4	16	18	32	0,05	0,3	3,7	1,7	3,3	●
T1.4.40.21.005L/R	4	4	21	23	37	0,05	0,3	3,7	1,7	3,3	●
T1.4.40.11.020L/R	4	4	11	13	27	0,20	0,3	3,7	1,7	3,3	●
T1.4.40.16.020L/R	4	4	16	18	32	0,20	0,3	3,7	1,7	3,3	●
T1.4.40.21.020L/R	4	4	21	23	37	0,20	0,3	3,7	1,7	3,3	●
T1.5.50.11.020L/R	5	5	11	13	27	0,20	0,5	4,6	2,1	4	●
T1.5.50.16.020L/R	5	5	16	18	32	0,20	0,5	4,6	2,1	4	●
T1.5.50.21.020L/R	5	5	21	23	37	0,20	0,5	4,6	2,1	4	●
T1.5.50.31.020L/R	5	5	31	33	47	0,20	0,5	4,6	2,1	4	●
T1.6.60.16.020L/R	6	6	16	18	32	0,20	0,5	5,6	2,6	5	●
T1.6.60.21.020L/R	6	6	21	23	37	0,20	0,5	5,6	2,6	5	●
T1.6.60.26.020L/R	6	6	26	28	42	0,20	0,5	5,6	2,6	5	●
T1.6.60.36.020L/R	6	6	36	38	52	0,20	0,5	5,6	2,6	5	●
T1.7.68.21.020L/R	7	6,8	21	23	37	0,20	0,5	6,3	2,8	5,7	●
T1.7.68.26.020L/R	7	6,8	26	28	42	0,20	0,5	6,3	2,8	5,7	●
T1.7.68.31.020L/R	7	6,8	31	33	47	0,20	0,5	6,3	2,8	5,7	●
T1.7.68.41.020L/R	7	6,8	41	43	57	0,20	0,5	6,3	2,8	5,7	●

● Ab Lager ○ Auf Anfrage ● Ex stock ○ On demand

Ab Seite 25 - on Page 25

Unbeschichtete Sorte (HW) YD201
Uncoated Grade (HW) YD 201

Auf Anfrage - on request

HC¹ Coated carbide
HW Uncoated carbide, main component (WC)

Ausdrehen und Kopieren - Turning and Profiling

mit Eckenradius, mit Spanbrecher, stirnseitig 0° - with corner radius, with chip breaker, front side 0°

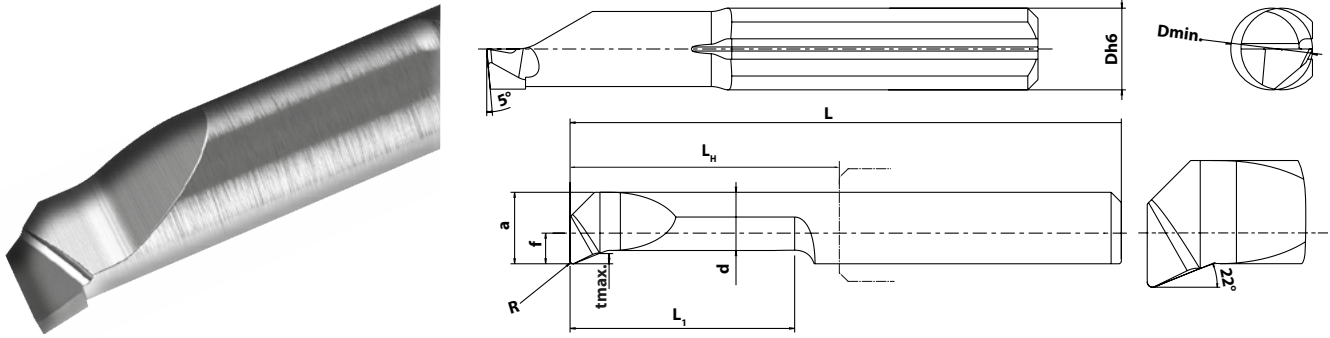

Abmessungen / Dimensions [mm]

Artikel /Article	Dh6	Dmin	L1	LH	L	R	tmax	a	f	d	HC ¹ (PVD)
											YPG201
T2.4.40.11.015L/R	4	4	11	13	27	0,15	0,5	3,5	1,5	2,9	●
T2.4.40.16.015L/R	4	4	16	18	32	0,15	0,5	3,5	1,5	2,9	○
T2.5.50.11.015L/R	5	5	11	13	27	0,15	0,7	4,4	1,9	3,6	●
T2.5.50.16.015L/R	5	5	16	18	32	0,15	0,7	4,4	1,9	3,6	○
T2.5.50.21.015L/R	5	5	21	23	37	0,15	0,7	4,4	1,9	3,6	○
T2.6.60.16.015L/R	6	6	16	18	32	0,15	0,9	5,4	2,4	4,4	●
T2.6.60.21.015L/R	6	6	21	23	37	0,15	0,9	5,4	2,4	4,4	○

● Ab Lager ○ Auf Anfrage ● Ex stock ○ On demand

Ab Seite 25 - on Page 25

Unbeschichtete Sorte (HW) YD201
Uncoated Grade (HW) YD 201

Auf Anfrage - on request

HC¹ Coated carbide
HW Uncoated carbide, main component (WC)

Ausdrehen und Kopieren - Turning and Profiling

mit Eckenradius, 47° Freiwinkel - with corner radius, 47° clearance angle

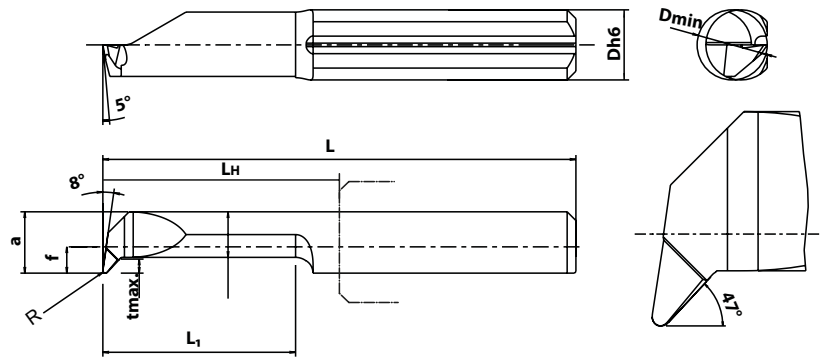

Abmessungen / Dimensions [mm]

Artikel /Article	D _{h6}	D _{min}	L ₁	L _H	L	R	t _{max}	a	f	d	HC ¹ (PVD)
											YPG201
T3.4.22.11.010L/R	4	2,2	11	13	27	0,1	0,4	1,95	0,6	1,45	○
T3.4.27.16.010L/R	4	2,7	16	18	32	0,1	0,5	2,45	0,45	1,85	●
T3.4.32.16.010L/R	4	3,2	16	18	32	0,1	0,6	2,95	0,95	2,25	●
T3.4.40.11.015L/R	4	4	11	13	27	0,15	0,8	3,5	1,5	2,6	●
T3.4.40.16.015L/R	4	4	16	18	32	0,15	0,8	3,5	1,5	2,6	●
T3.4.40.21.015L/R	4	4	21	23	37	0,15	0,8	3,5	1,5	2,6	●
T3.5.50.16.015L/R	5	5	11	13	27	0,15	1	4,4	1,9	3,3	●
T3.5.50.26.015L/R	5	5	26	28	42	0,15	1	4,4	1,9	3,3	●
T3.6.60.21.015L/R	6	6	21	23	37	0,15	1,8	5,3	2,3	3,4	●
T3.6.60.31.015L/R	6	6	31	33	47	0,15	1,8	5,3	2,3	3,4	●

● Ab Lager ○ Auf Anfrage ● Ex stock ○ On demand

Ab Seite 25 - on Page 25

Unbeschichtete Sorte (HW) YD201
Uncoated Grade (HW) YD 201

Auf Anfrage - on request

HC¹ Coated carbide
HW Uncoated carbide, main component (WC)

Ausdrehen und Kopieren - Turning and Profiling

mit Eckenradius, stirnseitig 20° - with corner radius, front side 20°

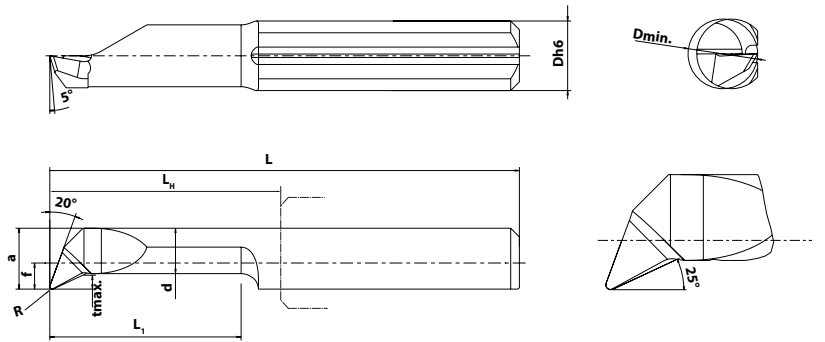

Abmessungen / Dimensions [mm]

Artikel /Article	Dh6	Dmin	L1	LH	L	R	tmax	a	f	d	HC ¹ (PVD)
											YPG201
T4.4.27.06.010L/R	4	2,7	6	8	22	0,1	0,3	2,45	0,45	2,05	○
T4.4.27.11.010L/R	4	2,7	11	13	27	0,1	0,3	2,45	0,45	2,05	●
T4.4.27.16.010L/R	4	2,7	16	18	32	0,1	0,3	2,45	0,45	2,05	●
T4.4.40.11.015L/R	4	4	11	13	27	0,15	0,8	3,5	1,5	2,6	●
T4.4.40.16.015L/R	4	4	16	18	32	0,15	0,8	3,5	1,5	2,6	●
T4.4.40.21.015L/R	4	4	21	23	37	0,15	0,8	3,5	1,5	2,6	○
T4.5.50.11.020L/R	5	5	11	13	27	0,2	1	4,4	1,9	3,3	○
T4.5.50.26.020L/R	5	5	26	28	42	0,2	1	4,4	1,9	3,3	●
T4.6.60.21.020L/R	6	6	21	23	37	0,2	1,8	5,3	2,3	3,4	●
T4.6.60.31.020L/R	6	6	31	33	47	0,2	1,8	5,3	2,3	3,4	●

● Ab Lager ○ Auf Anfrage ● Ex stock ○ On demand

Ab Seite 25 - on Page 25

Unbeschichtete Sorte (HW) YD201
Uncoated Grade (HW) YD 201

Auf Anfrage - on request

HC¹ Coated carbide
HW Uncoated carbide, main component (WC)

Ausdrehen und Fasen - Profiling and Chamfering

mit Eckenradius und 45° Fase - with corner radius and 45° chamfer

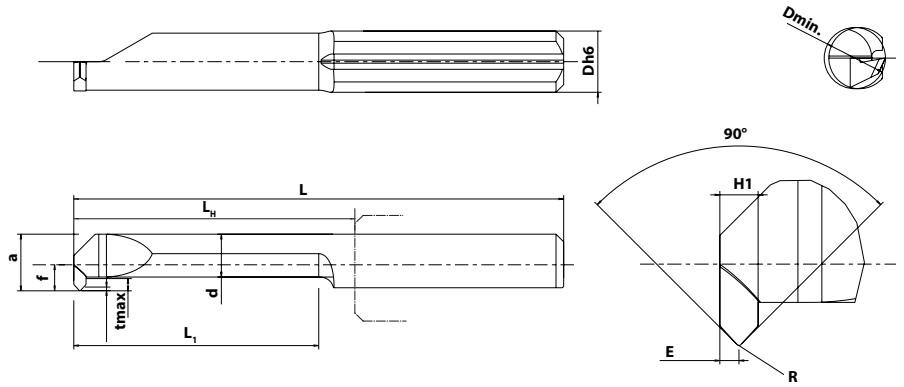
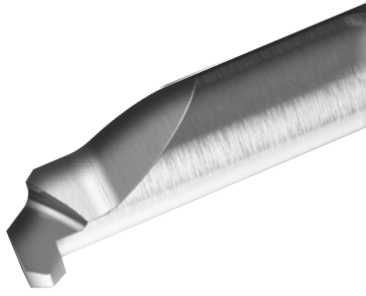

Abmessungen / Dimensions [mm]

Artikel /Article	Dh6	Dmin	L1	LH	L	R	tmax	a	f	d	E	H1	HC ¹ (PVD)
													YPG201
C1.4.40.16.005R L/R	4	4	16	18	32	0,5	0,8	3,7	1,7	2,8	0,4	0,23	○
C1.5.50.21.010R L/R	5	5	21	23	37	0,1	1,2	4,4	1,9	3,1	0,7	0,5	●
C1.6.60.26.015R L/R	6	6	26	28	42	0,15	1,4	5,3	2,3	3,8	0,7	0,5	○
C1.7.68.41.020R L/R	7	7	41	43	57	0,2	1,8	6,3	2,8	4,4	1	0,7	○

● Ab Lager ○ Auf Anfrage ● Ex stock ○ On demand

Ab Seite 25 - on Page 25

Unbeschichtete Sorte (HW) YD201
Uncoated Grade (HW) YD 201

Auf Anfrage - on request

HC¹ Coated carbide
HW Uncoated carbide, main component (WC)

Rückwärtsbearbeitung - Back Turning

mit Eckenradius, 45° Fase - with corner radius, 45° chamfer

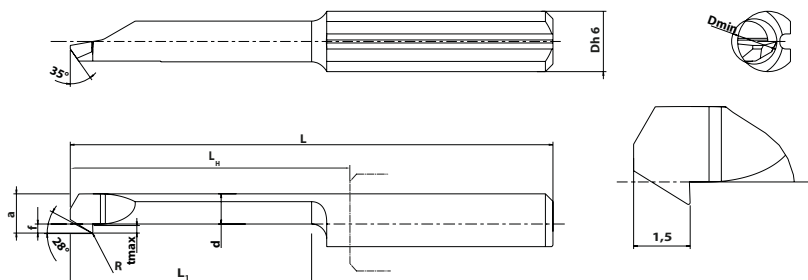
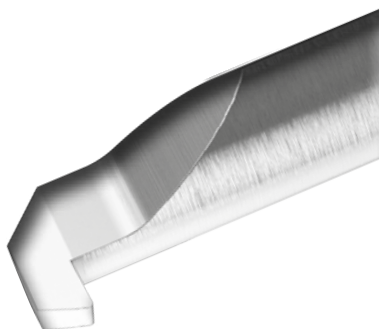

Abmessungen / Dimensions [mm]

Artikel /Article	Dh6	Dmin	L1	LH	L	R	tmax	a	f	d	HC ¹ (PVD)
											YPG201
B1.4.30.16.005L/R	4	3	16	18	32	0,05	0,5	2,6	0,6	2	●
B1.4.40.21.010L/R	4	4	21	23	37	0,1	0,8	3,5	1,5	2,6	●
B1.5.50.31.0151L/R	5	5	31	33	47	0,15	1	4,4	1,9	3,3	●
B1.6.60.31.015L/R	6	6	31	33	47	0,15	1,8	5,3	2,3	3,4	○
B1.7.70.31.015L/R	7	7	31	33	47	0,15	2,5	6,3	2,8	3,7	○
B1.4.30.16.005L/R	4	3	16	18	32	0,05	0,5	2,6	0,6	2	○
B1.4.40.21.010L/R	4	4	21	23	37	0,1	0,8	3,5	1,5	2,6	●
B1.5.50.31.0151L/R	5	5	31	33	47	0,15	1	4,4	1,9	3,3	●
B1.6.60.31.015L/R	6	6	31	33	47	0,15	1,8	5,3	2,3	3,4	○
B1.7.70.31.015L/R	7	7	31	33	47	0,15	2,5	6,3	2,8	3,7	●

● Ab Lager ○ Auf Anfrage ● Ex stock ○ On demand

Ab Seite 25 - on Page 25

Unbeschichtete Sorte (HW) YD201
Uncoated Grade (HW) YD 201

Auf Anfrage - on request

HC¹ Coated carbide
HW Uncoated carbide, main component (WC)

Stechen - Grooving

Stechen mit & ohne Eckenradius - Grooving with & without corner radius

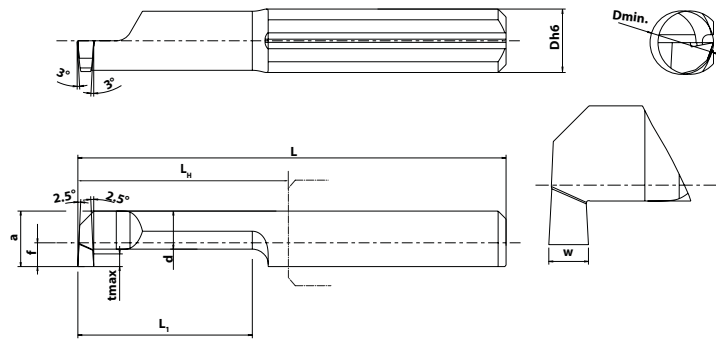
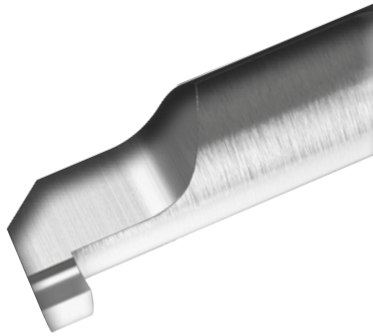

Abmessungen / Dimensions [mm]

Artikel /Article	Dh6	Dmin	L1	LH	L	w+0,05	tmax	a	f	d	HC ¹ (PVD)
											YPG201
G1.4.20.06.05L/R	4	2	6	8	22	0,5	0,4	1,75	0,6	1,15	●
G1.4.20.11.05L/R	4	2	11	13	27	0,5	0,4	1,75	0,6	1,15	○
G1.4.30.06.07L/R	4	3	6	8	22	0,75	0,6	2,7	0,7	1,9	●
G1.4.30.11.07L/R	4	3	11	13	27	0,75	0,6	2,7	0,7	1,9	○
G1.4.40.11.10L/R	4	4	11	13	27	1	0,8	3,5	1,5	2,4	●
G1.4.40.16.10L/R	4	4	16	18	32	1	0,8	3,5	1,5	2,4	○
G1.5.50.16.10L/R	5	5	16	18	32	1	1	4,4	1,9	3,2	●
G1.5.50.21.10L/R	5	5	21	23	37	1	1	4,4	1,9	3,2	●
G1.5.50.26.10L/R	5	5	26	28	42	1	1	4,4	1,9	3,2	○
G1.5.50.31.10L/R	5	5	31	33	47	1	1	4,4	1,9	3,2	○
G1.5.50.16.15L/R	5	5	16	18	32	1,5	1	4,4	1,9	3,2	●
G1.5.50.21.15L/R	5	5	21	23	37	1,5	1	4,4	1,9	3,2	●
G1.5.50.26.15L/R	5	5	26	28	42	1,5	1	4,4	1,9	3,2	○
G1.5.50.31.15L/R	5	5	31	33	47	1,5	1	4,4	1,9	3,2	●
G1.5.50.16.20L/R	5	5	16	18	32	2	1	4,4	1,9	3,2	●
G1.5.50.21.20L/R	5	5	21	23	37	2	1	4,4	1,9	3,2	●
G1.5.50.26.20L/R	5	5	26	28	42	2	1	4,4	1,9	3,2	○
G1.5.50.31.20L/R	5	5	31	33	47	2	1	4,4	1,9	3,2	○
G1.6.60.16.10L/R	6	6	16	18	32	1	1,8	5,3	2,3	3,3	○
G1.6.60.21.10L/R	6	6	21	23	37	1	1,8	5,3	2,3	3,3	●
G1.6.60.26.10L/R	6	6	26	28	42	1	1,8	5,3	2,3	3,3	●
G1.6.60.36.10L/R	6	6	36	38	52	1	1,8	5,3	2,3	3,3	○
G1.6.60.16.15L/R	6	6	16	18	32	1,5	1,8	5,3	2,3	3,3	○
G1.6.60.21.15L/R	6	6	21	23	37	1,5	1,8	5,3	2,3	3,3	●

● Ab Lager ○ Auf Anfrage ● Ex stock ○ On demand

Ab Seite 25 - on Page 25

Unbeschichtete Sorte (HW) YD201
Uncoated Grade (HW) YD 201

Auf Anfrage - on request

HC¹ Coated carbide
HW Uncoated carbide, main component (WC)

Stechen - Grooving

Stechen mit & ohne Eckenradius - Grooving with & without corner radius

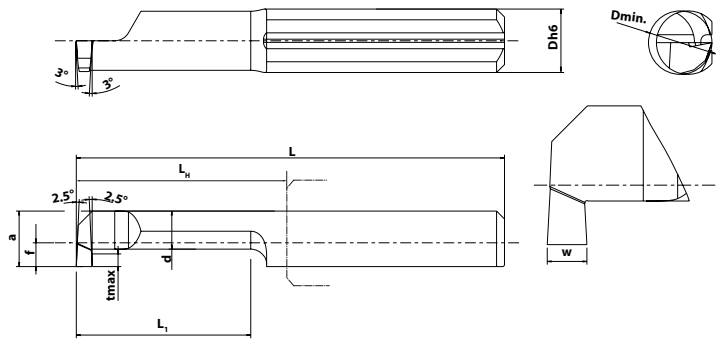

G1

Abmessungen / Dimensions [mm]

Artikel /Article	Dh6	Dmin	L1	LH	L	w+0,05	tmax	a	f	d	HC ¹ (PVD)
											YPG201
G1.6.60.26.15L/R	6	6	26	28	42	1,5	1,8	5,3	2,3	3,3	●
G1.6.60.36.15L/R	6	6	36	38	52	1,5	1,8	5,3	2,3	3,3	○
G1.6.60.16.20L/R	6	6	16	18	32	2	1,8	5,3	2,3	3,3	○
G1.6.60.21.20L/R	6	6	21	23	37	2	1,8	5,3	2,3	3,3	●
G1.6.60.26.20L/R	6	6	26	28	42	2	1,8	5,3	2,3	3,3	●
G1.6.60.31.20L/R	6	6	31	33	47	2	1,8	5,3	2,3	3,3	○
G1.7.70.16.10L/R	7	7	16	18	32	1	2,5	6,3	2,8	3,6	○
G1.7.70.26.10L/R	7	7	26	28	42	1	2,5	6,3	2,8	3,6	●
G1.7.70.31.10L/R	7	7	31	33	47	1	2,5	6,3	2,8	3,6	●
G1.7.70.36.10L/R	7	7	36	38	52	1	2,5	6,3	2,8	3,6	○
G1.7.70.46.10L/R	7	7	46	48	62	1	2,5	6,3	2,8	3,6	○
G1.7.70.16.15L/R	7	7	16	18	32	1,5	2,5	6,3	2,8	3,6	○
G1.7.70.26.15L/R	7	7	26	28	42	1,5	2,5	6,3	2,8	3,6	●
G1.7.70.31.15L/R	7	7	31	33	47	1,5	2,5	6,3	2,8	3,6	●
G1.7.70.36.15L/R	7	7	36	38	52	1,5	2,5	6,3	2,8	3,6	○
G1.7.70.41.15L/R	7	7	41	43	57	1,5	2,5	6,3	2,8	3,6	○
G1.7.70.16.20L/R	7	7	16	18	32	2	2,5	6,3	2,8	3,6	○
G1.7.70.26.20L/R	7	7	26	28	42	2	2,5	6,3	2,8	3,6	●
G1.7.70.31.20L/R	7	7	31	33	47	2	2,5	6,3	2,8	3,6	●
G1.7.70.36.20L/R	7	7	36	38	52	2	2,5	6,3	2,8	3,6	○
G1.7.70.41.20L/R	7	7	41	43	57	2	2,5	6,3	2,8	3,6	○

● Ab Lager ○ Auf Anfrage ● Ex stock ○ On demand

Ab Seite 25 - on Page 25

Unbeschichtete Sorte (HW) YD201
Uncoated Grade (HW) YD 201

Auf Anfrage - on request

HC¹ Coated carbide
HW Uncoated carbide, main component (WC)

Stechen - Grooving

Stechdrehen & Kopieren mit Vollradius - Grooving & Profiling with full radius

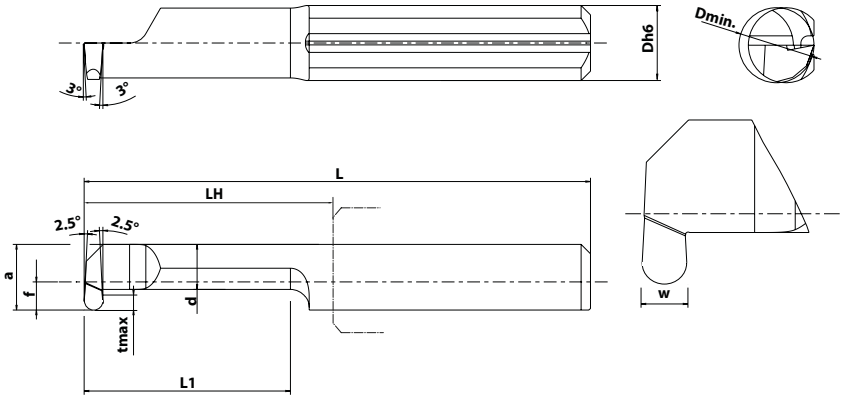
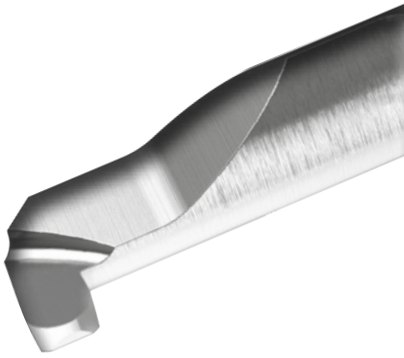

Abmessungen / Dimensions [mm]

Artikel /Article	Dh6	Dmin	L1	LH	L	R	w+0,05	tmax	a	f	d	HC ¹ (PVD)
												YPG201
G2.4.40.16.050.10L/R	4	4	16	18	32	0,5	1	0,8	3,5	1,5	2,5	○
G2.5.50.21.050.10L/R	5	5	21	23	37	0,5	1	1	4,4	1,9	3,2	●
G2.5.50.21.075.15L/R	5	5	21	23	37	0,75	1,5	1	4,4	1,9	3,2	●
G2.6.60.26.050.10L/R	6	6	26	28	42	0,5	1	1,8	5,3	2,3	3,3	●
G2.6.60.26.100.20L/R	6	6	26	28	42	1	2	1,8	5,3	2,3	3,3	●
G2.7.70.31.075.15L/R	7	7	31	33	47	0,75	1,5	2,5	6,3	2,8	3,6	○
G2.7.70.31.100.20L/R	7	7	31	33	47	1	2	2,5	6,3	2,8	3,6	○

● Ab Lager ○ Auf Anfrage ● Ex stock ○ On demand

Ab Seite 25 - on Page 25

Unbeschichtete Sorte (HW) YD201
Uncoated Grade (HW) YD 201

Auf Anfrage - on request

HC¹ Coated carbide
HW Uncoated carbide, main component (WC)

Gewindedrehen - Threading

Teilprofil 60° - Partial profile 60°

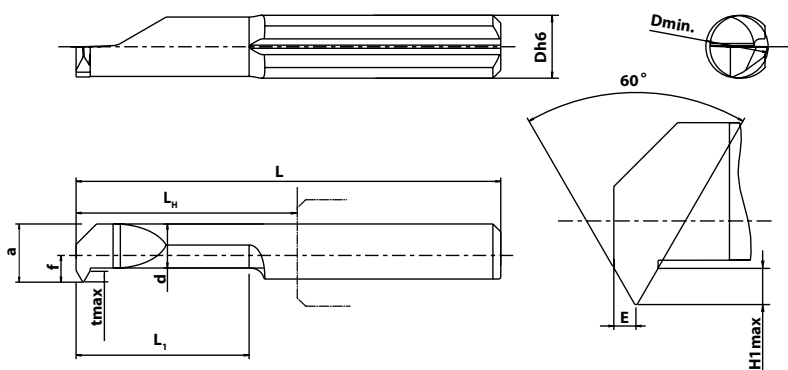
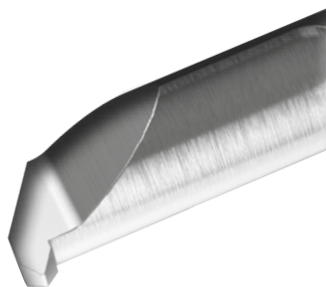

Abmessungen / Dimensions [mm]

Artikel /Article	Dh6	Dmin	L1	LH	L	P	a	f	d	E	H1max	rmin	HC ¹ (PVD)
													YPG201
P1.4.24.11.601L/R	4	2,4	11	13	27	0.5-0.7 / 48-36	2,2	0,2	1,6	0,35	0,43	0,03	●
P1.4.38.16.601L/R	4	3,8	16	18	32	0.5-0.7 / 48-36	3,7	1,7	2,8	0,35	0,43	0,03	●
P1.4.38.11.602L/R	4	3,8	11	13	27	0.5-1.0 / 48-24	3,7	1,7	2,8	0,45	0,66	0,03	●
P1.5.48.16.602L/R	5	4,8	16	18	32	0.5-1.0 / 48-24	4,7	2,2	3,2	0,45	0,66	0,03	○
P1.5.48.16.603L/R	5	4,8	16	18	32	1.0-1.5 / 24-16	4,7	2,2	3,2	0,7	0,97	0,06	●
P1.6.58.21.603L/R	6	5,8	21	23	37	1.0-1.5 / 24-16	5,5	2,5	4	0,7	0,97	0,03	○

● Ab Lager ○ Auf Anfrage ● Ex stock ○ On demand

Ab Seite 25 - on Page 25

Unbeschichtete Sorte (HW) YD201
Uncoated Grade (HW) YD 201

Auf Anfrage - on request

HC¹ Coated carbide
HW Uncoated carbide, main component (WC)

Gewindedrehen - Threading

metr. ISO Regel- & Feingewinde Vollprofil 60° - ISO metric & fine thread full profile 60°

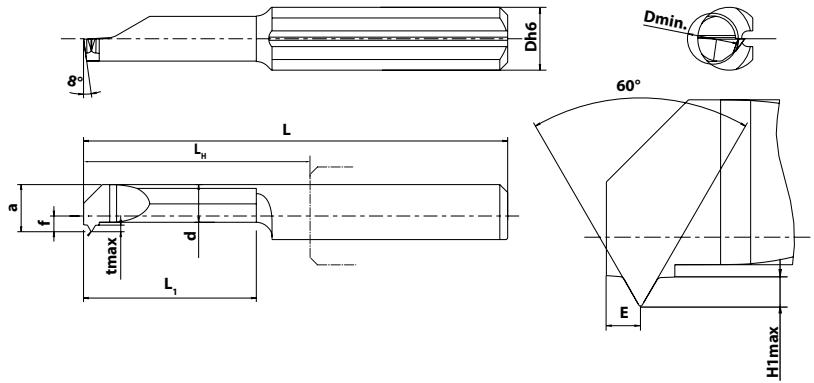
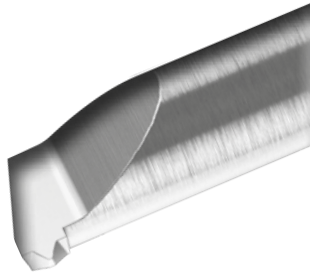

Abmessungen / Dimensions [mm]

Artikel /Article	Dh6	Dmin	L1	LH	L	P	a	f	d	E	H1max	rmin	HC ¹ (PVD)
													YPG201
P2.4.34.11.050 L/R	4	MF4x0.5	11	13	27	0,5	3,3	1,3	2,65	0,35	0,27	0,29	○
P2.5.50.16.050 L/R	5	MF6x0.5	16	18	32	0,5	4,4	1,9	3,3	0,35	0,27	0,29	○
P2.4.32.11.070 L/R	4	M4x0.7	11	13	27	0,7	3	1	2,4	0,5	0,38	0,41	○
P2.5.54.16.075 L/R	5	MF6x0.75	16	18	32	0,75	4,7	2,2	3,8	0,55	0,41	0,45	○
P2.4.40.11.080 L/R	4	M5x0.8	11	13	27	0,8	3,9	1,9	2,8	0,55	0,43	0,47	○
P2.5.48.16.100 L/R	5	M6x1/ MF8x1	16	18	32	1	4,5	2	3,4	0,7	0,54	0,59	○
P2.6.58.21.100 L/R	6	M7x1/MF8x1	21	23	37	1	5,5	2,5	4,4	0,7	0,54	0,59	○
P2.6.65.21.125 L/R	6	M8x1.25 /MF10x1.25	21	23	37	1,25	5,9	2,9	4,8	0,9	0,68	0,73	○

● Ab Lager ○ Auf Anfrage ● Ex stock ○ On demand

Ab Seite 25 - on Page 25

Unbeschichtete Sorte (HW) YD201
Uncoated Grade (HW) YD 201

Auf Anfrage - on request

HC¹ Coated carbide
HW Uncoated carbide, main component (WC)

Gewindedrehen - Threading

Teilprofil 55° - Partial profile 55°

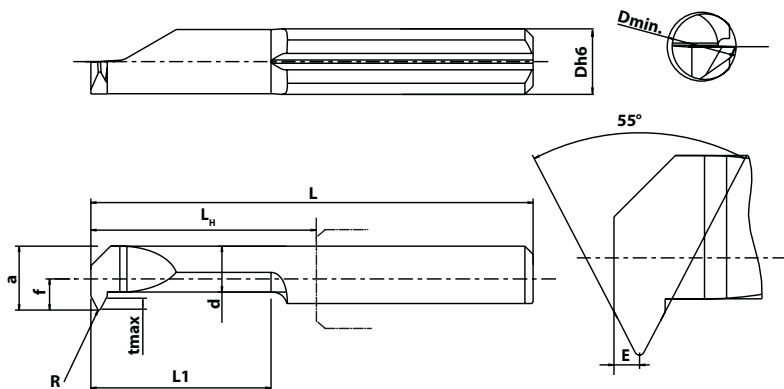
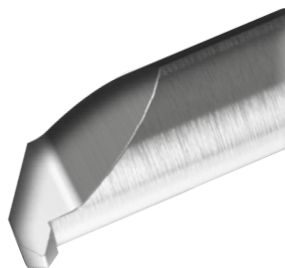

Abmessungen / Dimensions [mm]

Artikel /Article	Dh6	Dmin	L1	LH	L	P	a	f	d	E	H1max	rmin	HC ¹ (PVD)
													YPG201
P3.4.40.11.551L/R	4	4,2	11	13	27	28-24	3,9	1,9	2,8	0,5	0,677	0,125	●
P3.5.47.16.552L/R	5	4,7	16	18	32	20-16	3,9	1,9	3,3	0,35	1,017	0,17	●

● Ab Lager ○ Auf Anfrage ● Ex stock ○ On demand

Ab Seite 25 - on Page 25

Unbeschichtete Sorte (HW) YD201
Uncoated Grade (HW) YD 201

Auf Anfrage - on request

HC¹ Coated carbide
HW Uncoated carbide, main component (WC)

Gewindedrehen - Threading

Whitworth-Gewinde Vollprofil 55° - Whitworth-Thread full profile 55°

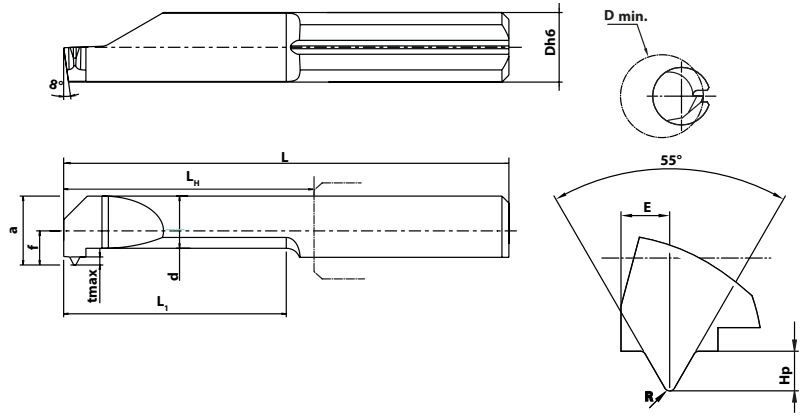
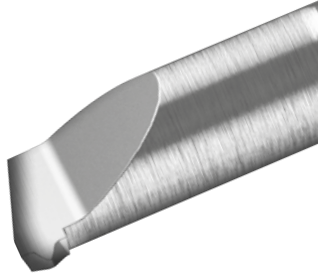

Abmessungen / Dimensions [mm]

Artikel /Article	Dh6	Dmin	L1	LH	L	P	a	f	d	E	Hp	HC ¹ (PVD)
												YPG201
P4.5.52.16.TPI28L/R	5	1/16"-28BSP / G1/16"	16	18	32	28	4,95	2,45	3,75	0,8	0,58	○
P4.6.62.16.TPI19L/R	6	1/4"-19BSP / G1/4"	16	18	32	19	5,95	2,95	3,75	1	0,86	○

● Ab Lager ○ Auf Anfrage ● Ex stock ○ On demand

Ab Seite 25 - on Page 25

Unbeschichtete Sorte (HW) YD201
Uncoated Grade (HW) YD 201

Auf Anfrage - on request

HC¹ Coated carbide
HW Uncoated carbide, main component (WC)

Axial / Einstechen - Face Grooving

mit Eckenradius, innen - with corner radius, internal

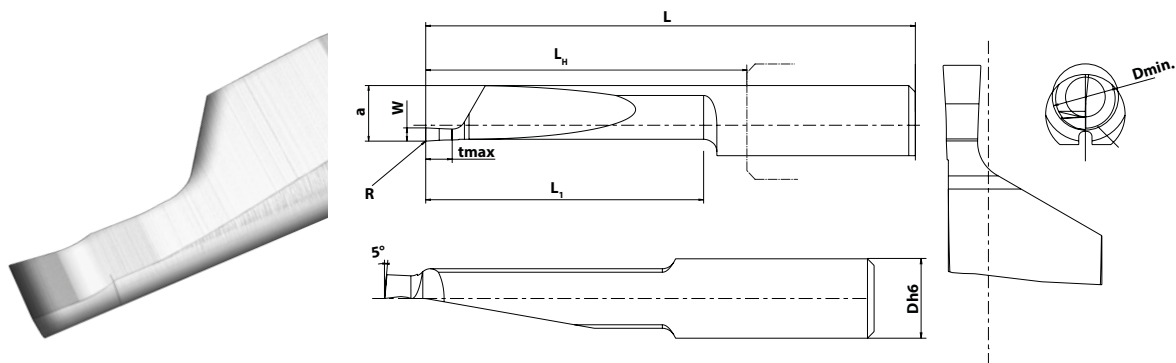

F1

Abmessungen / Dimensions [mm]

Artikel / Article	Dh6	Dmin	L1	LH	L	R	w+0,05	tmax	a	HC ¹ (PVD)
										YPG201
F1.6.50.21.003.10L/R	6	5	21	23	37	0,03	1	2	4,2	●
F1.6.50.21.005.15L/R	6	5	21	23	37	0,05	1,5	3	4,2	●
F1.6.50.21.005.20L/R	6	5	21	23	37	0,05	2	5	4,2	●
F1.6.60.21.005.10L/R	6	6	21	23	37	0,05	1	2	5,2	○
F1.6.60.21.005.15L/R	6	6	21	23	37	0,05	1,5	3	5,2	○
F1.6.60.21.005.20L/R	6	6	21	23	37	0,05	2	5	5,2	●
F1.6.60.16.005.25L/R	6	6	16	18	31	0,05	2,5	5	5,2	●
F1.7.80.21.008.10L/R	7	8	21	23	37	0,08	1	2	5,9	○
F1.7.80.21.015.15L/R	7	8	21	23	37	0,15	1,5	3	5,9	○
F1.7.80.21.015.20L/R	7	8	21	23	37	0,15	2	4	5,9	○
F1.7.80.21.015.25L/R	7	8	21	23	37	0,15	2,5	5	5,9	●
F1.7.80.21.015.30L/R	7	8	21	23	37	0,15	3	6	5,9	●

● Ab Lager ○ Auf Anfrage ● Ex stock ○ On demand



Ab Seite 25 - on Page 25

Unbeschichtete Sorte (HW) YD201
Uncoated Grade (HW) YD 201

Auf Anfrage - on request

R = rechts, wie gezeichnet

R = right, according drawing

HC¹ Coated carbide

HW Uncoated carbide, main component (WC)

Axial / Einstechen - Face Grooving

mit Eckenradius, für die Zapfenbearbeitung - with corner radius, for pivots application

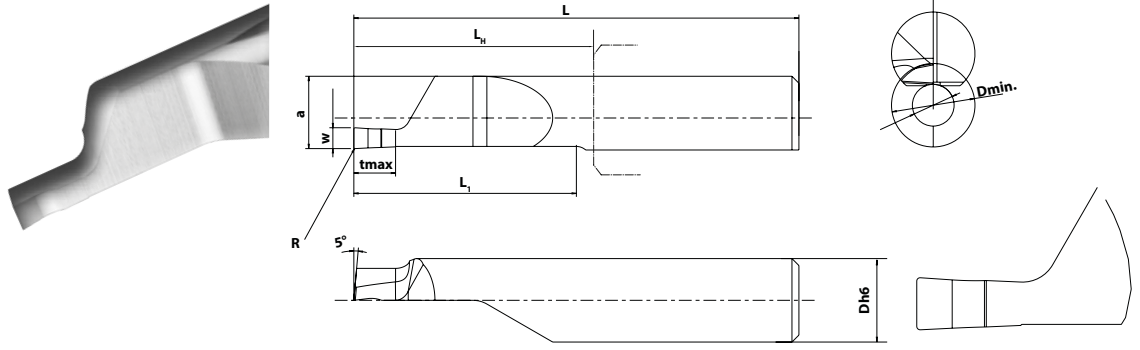

Abmessungen / Dimensions [mm]

Artikel / Article	Dh6	Dmin	L1	LH	L	R	w+0,05	tmax	a	HC ¹ (PVD)
										YPG201
F2.6.60.16.010.15L/R	6	6	16	18	31	0,1	1,5	5	4,2	●
F2.6.60.16.015.20L/R	6	6	16	18	31	0,15	2	3,15	5,2	●
F2.6.60.16.015.25L/R	6	6	16	18	31	0,15	2,5	5	5,2	○
F2.6.65.16.015.30L/R	6	6,5	16	18	31	0,15	3	6	5,2	●

● Ab Lager ○ Auf Anfrage ● Ex stock ○ On demand

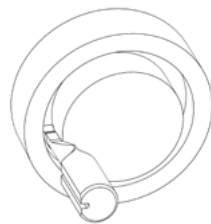

Ab Seite 25 - on Page 25

Unbeschichtete Sorte (HW) YD201
Uncoated Grade (HW) YD 201

Auf Anfrage - on request

R = rechts, wie gezeichnet

R = right, according drawing

HC¹ Coated carbide

HW Uncoated carbide, main component (WC)

Axial / Einstechen - Face Grooving

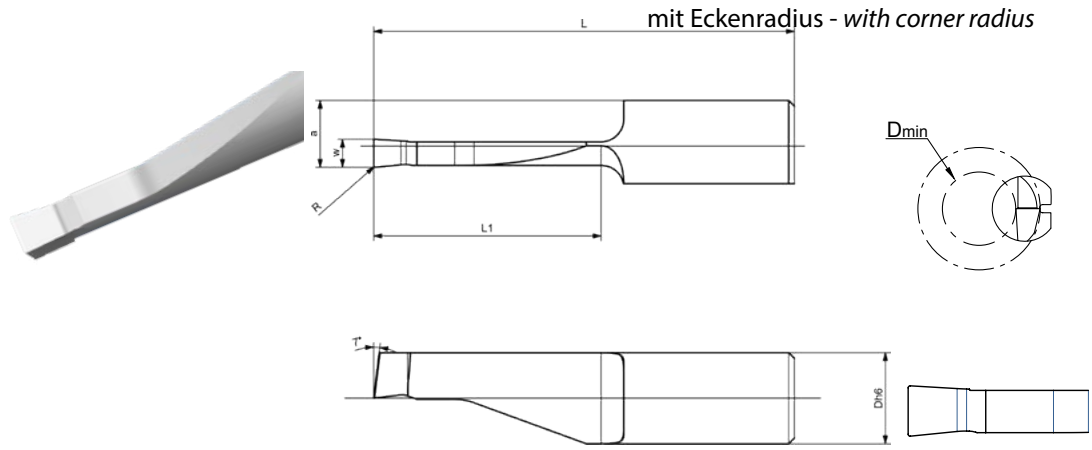

Abmessungen / Dimensions [mm]

Artikel / Article	Dh6	Dmin	L1	LH	L	R	w+0,05	a	HC ¹ (PVD)
									YPG201
F3.8.150.15.030.20L/R	8	15	15	23	37	0,3	2	5,9	●
F3.8.150.20.030.20L/R	8	15	20	23	37	0,3	2	5,9	○
F3.8.150.15.030.30L/R	8	15	15	23	37	0,3	3	5,9	●
F3.8.150.20.030.30L/R	8	15	20	23	37	0,3	3	5,9	○
F3.8.150.20.030.40L/R	8	15	20	23	37	0,3	4	5,9	○
F3.8.150.40.030.40L/R	8	15	40	43	57	0,3	4	5,9	○
F3.8.150.20.030.50L/R	8	15	20	23	37	0,3	5	5,9	●
F3.8.150.40.030.50L/R	8	15	40	43	57	0,3	5	5,9	○

● Ab Lager ○ Auf Anfrage ● Ex stock ○ On demand

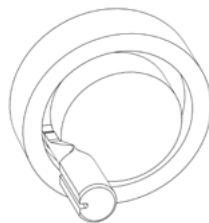

Ab Seite 25 - on Page 25

Unbeschichtete Sorte (HW) YD201
Uncoated Grade (HW) YD 201

Auf Anfrage - on request

R = rechts, wie gezeichnet

R = right, according drawing

HC¹ Coated carbide

HW Uncoated carbide, main component (WC)

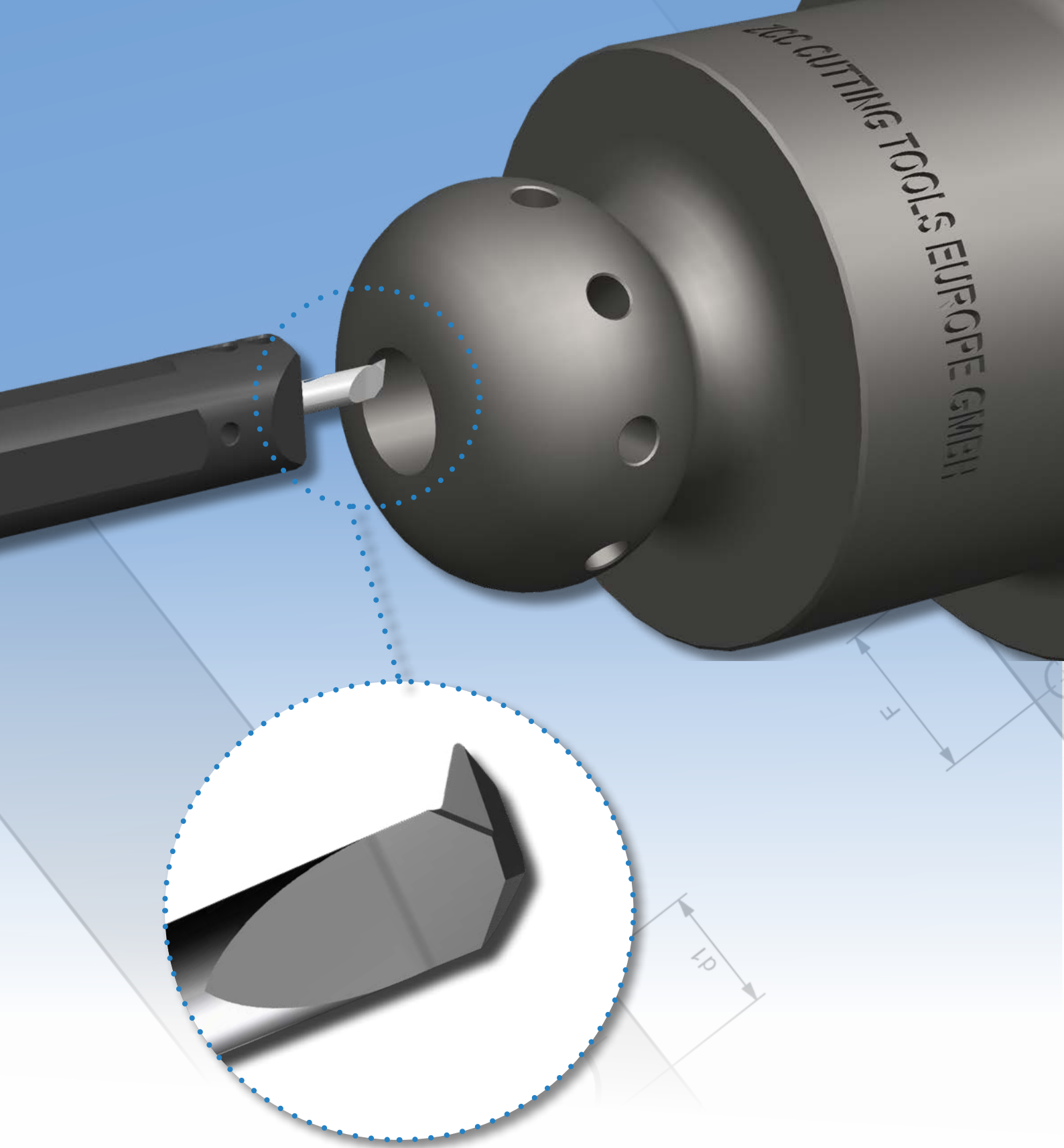

Economical machining of small components *Wirtschaftliche Zerspanung von kleinen Bauteilen*



- Präzisionsgeschliffene Mini-VHM-Werkzeuge
 - Universell einsetzbares System
 - Spanndurchmesser von 4 mm bis 7 mm
 - Bearbeitungsdurchmesser min. 1,0 mm bis 10,0 mm
 - High-Performance-Beschichtung YPG201
- Precision ground mini solid carbide tools
 - Universally applicable system
 - Clamping diameter of 4 mm to 7 mm
 - Working diameter min. 1.0 mm to 10.0 mm
 - High performance coating YPG201

Halter + IK - Toolholder with internal coolant

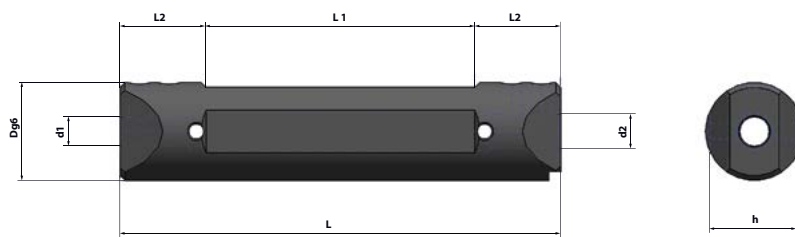
Halter doppelseitig - Double sided holder



DH

Abmessungen / Dimensions [mm]										Schraube Screw d1	Schraube Screw d2	Schlüssel Wrench
Artikel /Article	Dg6	d1	d2	L	L1	L2	h	IG	Lager Stock			
DH1600.4.5	16	4	5	80	50	15	15	-	●	M5x6MT	M5x5MT	WT25L
DH1600.6.7	16	6	7	80	50	15	15	-	●	M5x5MT	M5x4MT	WT25L
DH1905.4.5	19,05	4	5	90	55	17,5	18	-	○	M5x6MT	M5x6MT	WT25L
DH1905.6.7	19,05	6	7	90	55	17,5	18	-	○	M5x6MT	M5x6MT	WT25L
DH2000.4.5	20	4	5	90	55	17,5	19	-	●	M5x8MT	M5x6MT	WT25L
DH2000.6.7	20	6	7	90	55	17,5	19	-	●	M5x6MT	M5x6MT	WT25L
DH2200.4.5	22	4	5	90	55	17,5	19	-	○	M5x8MT	M5x8MT	WT25L
DH2200.6.7	22	6	7	90	55	17,5	19	-	○	M5x8MT	M5x6MT	WT25L
DH2500.4.5	25	4	5	105	75	15	24	-	●	M5x10MT	M5x10MT	WT25L
DH2500.6.7	25	6	7	105	75	15	24	-	●	M5x8MT	M5x8MT	WT25L
DH2540.4.5	25,4	4	5	105	75	15	24,4	-	○	M5x10MT	M5x10MT	WT25L
DH2540.6.7	25,4	6	7	105	75	15	24,4	-	○	M5x8MT	M5x8MT	WT25L



● Ab Lager ○ Auf Anfrage ● Ex stock ○ On demand

Halter + IK - Toolholder with internal coolant

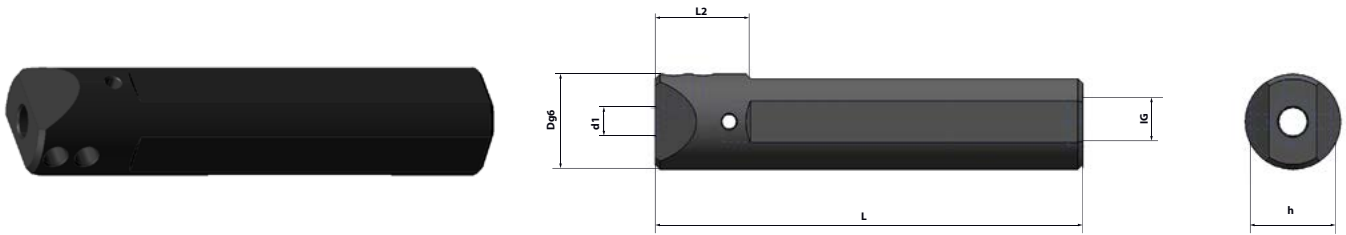
Halter einseitig - Single sided holder



SH

Artikel /Article	Abmessungen / Dimensions [mm]							Schraube Screw	Schlüssel Wrench
	Dg6	d1	L	L2	h	IG	Lager Stock		
SH1600.04	16	4	75	20	15	G1/8"	●	M5x6MT	WT25L
SH1600.05	16	5	75	20	15	G1/8"	●	M5x5MT	WT25L
SH1600.06	16	6	75	20	15	G1/8"	●	M5x5MT	WT25L
SH1600.07	16	7	75	20	15	G1/8"	●	M5x4MT	WT25L
SH1600.08	16	8	75	20	15	G1/8"	●	M5x4MT	WT25L
SH1905.04	19,05	4	90	20	18	G1/8"	○	M5x6MT	WT25L
SH1905.05	19,05	5	90	20	18	G1/8"	○	M5x6MT	WT25L
SH1905.06	19,05	6	90	20	18	G1/8"	○	M5x6MT	WT25L
SH1905.07	19,05	7	90	20	18	G1/8"	○	M5x6MT	WT25L
SH2000.04	20	4	90	20	19	G1/8"	●	M5x8MT	WT25L
SH2000.05	20	5	90	20	19	G1/8"	●	M5x6MT	WT25L
SH2000.06	20	6	90	20	19	G1/8"	●	M5x6MT	WT25L
SH2000.07	20	7	90	20	19	G1/8"	●	M5x6MT	WT25L
SH2000.08	20	8	90	20	19	G1/8"	●	M5x6MT	WT25L
SH2200.04	22	4	90	20	21	G1/8"	○	M5x8MT	WT25L
SH2200.05	22	5	90	20	21	G1/8"	○	M5x8MT	WT25L
SH2200.06	22	6	90	20	21	G1/8"	○	M5x8MT	WT25L
SH2200.07	22	7	90	20	21	G1/8"	○	M5x6MT	WT25L
SH2500.04	25	4	100	20	24	G1/8"	○	M5x10MT	WT25L
SH2500.05	25	5	100	20	24	G1/8"	○	M5x10MT	WT25L
SH2500.06	25	6	100	20	24	G1/8"	○	M5x8MT	WT25L
SH2500.07	25	7	100	20	24	G1/8"	○	M5x8MT	WT25L
SH2540.04	25,4	4	100	20	24	G1/8"	○	M5x10MT	WT25L
SH2540.05	25,4	5	100	20	24	G1/8"	○	M5x10MT	WT25L
SH2540.06	25,4	6	100	20	24	G1/8"	○	M5x8MT	WT25L
SH2540.07	25,4	7	100	20	24	G1/8"	○	M5x8MT	WT25L



● Ab Lager ○ Auf Anfrage ● Ex stock ○ On demand

Halter - Toolholder

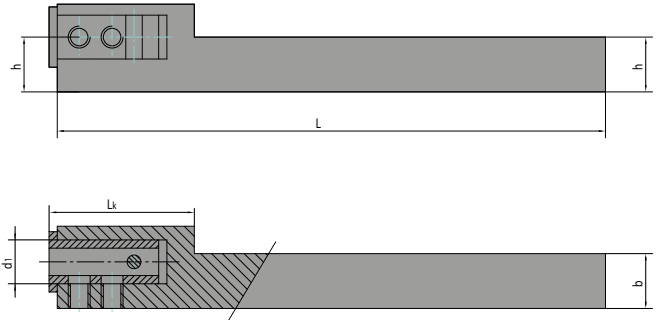
Quadratischer Stechhalter - Square Toolholder



QH

Abmessungen / Dimensions [mm]									Schraube Screw	Schlüssel Wrench
Artikel /Article	h	b	d1	L	L1	H1	B1	Lager Stock		
QH1010.08L/R	10	10	8	100	25	16	15	○	M5x6MT	WT25L
QH1212.08L/R	12	12	8	100	25	16	15	○	M5x6MT	WT25L
QH1616.12L/R	16	16	12	125	25	24,5	19,5	○	M5x8MT	WT25L



● Ab Lager ○ Auf Anfrage ● Ex stock ○ On demand

Halter - Toolholder

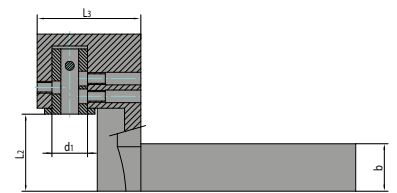
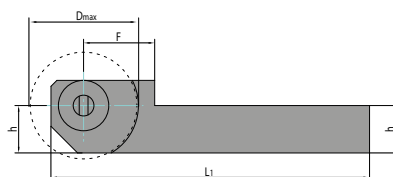
Quadratischer Stechhalter 90° - Square Toolholder 90°



QH
90



Abmessungen / Dimensions [mm]												Schraube Screw	Schlüssel Wrench	
Artikel /Article	h	b	d1	L	L1	L3	H1	B1	B2	Dmax	F	Lager Stock		
QH901010.08L/R	10	10	8	100	28	18	16,5	18	43	26	19	○	M5x8MT	WT25L
QH901212.12L/R	12	12	12	100	30	23	20,5	23	48	26	19	○	M5x8MT	WT25L
QH901616.12L/R	16	16	12	105	35	28	26	28	53	36	24	○	M5x8MT	WT25L

● Ab Lager ○ Auf Anfrage ● Ex stock ○ On demand

Halter - Toolholder

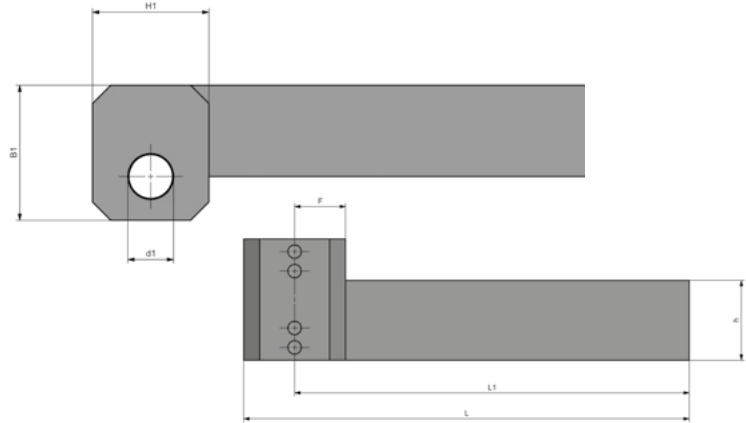
Quadratischer universal Stechhalter - *Square universal Toolholder*



Artikel / Article	Abmessungen / Dimensions [mm]									Schraube/ Srew	Schlüssel/ Wrench
	h	b	d1	L	L1	H1	B1	F	Lager Stock		
QHU2020.12L	20	20	12	140	124	32	37	16	●	M5x8MT	WT25L
QHU2020.12R	20	20	12	140	124	32	37	16	○	M5x8MT	WT25L
QHU2525.12L	25	25	12	140	124	32	37	16	●	M5x8MT	WT25L
QHU3232.12L	32	32	12	140	124	32	37	16	●	M5x8MT	WT25L

● Ab Lager ○ Auf Anfrage ● Ex stock ○ On demand

Reduzierhülse - Adapter sleeves

Reduzierhülse für Schneideinsätze Ø 4-8 mm Hülsen für R und L Einsätze universell einsetzbar Anzugsmoment: 1,1Nm
Adapter sleeves for inserts Ø 4 - 8 mm sleeves for right and left handed inserts universal usable. Tightening Torque: 1,1 Nm

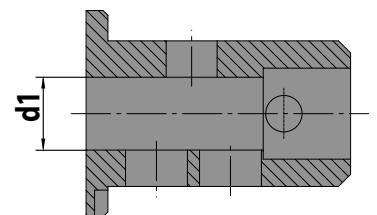
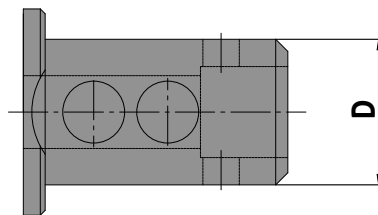
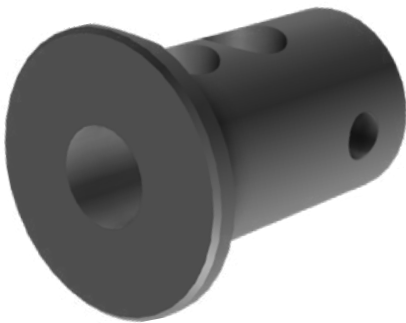

Artikel / Article	Abmessungen / Dimensions [mm]	
	d ₁	D
RS08.04	4	8
RS08.05	5	8
RS08.06	6	8
RS12.04	4	12
RS12.05	5	12
RS12.06	6	12
RS12.07	7	12
RS12.08	8	12

Schnittdatenempfehlungen

Werkstoffgruppe	Zusammensetzung/Gefüge/Wärmebehandlung		Brinell-Härte HB	Zerspanungsgruppe	Empfohlene Schnittgeschwindigkeit Vc [m/min]		
					Unbeschichtetes Hartmetall	PVD beschichtetes Hartmetall	
					HW	HC	
					YD201	YPG201	
					Drehen Vorschub [mm]	Drehen Vorschub [mm]	
					0,02-0,08	0,02-0,08	
					Stechdrehen Vorschub [mm]	Stechdrehen Vorschub [mm]	
					0,01-0,03	0,01-0,03	
P	Unlegierter Stahl	ca. 0,15 % C	geglüht	125	1	70	150
		ca. 0,45 % C	geglüht	190	2	70	135
		ca. 0,45 % C	vergütet	250	3	50	115
		ca. 0,75 % C	geglüht	270	4	45	110
		ca. 0,75 % C	vergütet	300	5	40	105
	Niedriglegierter Stahl		geglüht	180	6	55	135
			vergütet	275	7	45	100
			vergütet	300	8	40	90
			vergütet	350	9	40	85
	Hochlegierter Stahl und hochlegierter Werkzeugstahl		geglüht	200	10		100
		gehärtet und angelassen	325	11		75	
M	Nichtrostender Stahl	ferritisch/martensitisch	geglüht	200	12		120
		martensitisch	vergütet	240	13		100
		austenitisch	abgeschreckt	180	14		115
		austenitisch-ferritisch		230	15		100
K	Grauguss	perlitisch/ferritisch		180	16	55	165
		perlitisch (martensitisch)		260	17	45	145
	Gusseisen mit Kugelgraphit	ferritisch		160	18	65	175
		perlitisch		250	19	50	130
	Temperguss	ferritisch		130	20		135
		perlitisch		230	21		130
N	Aluminium-Knetlegierungen	nicht aushärtbar		60	22	200	400
		aushärtbar	ausgehärtet	100	23	150	300
	Aluminium-Gußlegierungen	≤ 12 % Si, nicht aushärtbar		75	24	100	200
		≤ 12 % Si, aushärtbar	ausgehärtet	90	25	80	160
		> 12 % Si, nicht aushärtbar		130	26	60	120
	Kupfer und Kupferlegierungen (Bronze/Messing)	Automatenlegierungen, PB > 1 %		110	27	60	120
		CuZn, CuSnZn		90	28	150	300
CuSn, bleifreies Kupfer und Elektrolytkupfer		100	29	60	120		
S	Warmfeste Legierungen	Fe-Basis	geglüht	200	30		75
			ausgehärtet	280	31		40
		Ni- oder Co-Basis	geglüht	250	32		60
			ausgehärtet	350	33		55
			gegossen	320	34		55
	Titanlegierungen	Reintitan		Rm 400	35		105
Alpha- + Beta-Legierungen		ausgehärtet	Rm 1050	36		40	
H	Gehärteter Stahl		gehärtet und angelassen	55 HRC	37		
			gehärtet und angelassen	60 HRC	38		
	Hartguss		gegossen	400	39		
	Gehärtetes Gusseisen		gehärtet und angelassen	55 HRC	40		
X	Nichtmetallische Werkstoffe	Thermoplaste			41		
		Duroplaste			42		
		Glasfaserverstärkter Kunststoff GFK			43		
		Kohlefaserverstärkter Kunststoff CFK			44		
		Graphit			45		
		Holz			46		

Hinweise: Bei den vorgegebenen Schnittdaten handelt es sich um Richtwerte, welche unter Idealbedingungen ermittelt wurden.

HC beschichtetes Hartmetall
HW unbeschichtetes Hartmetall, Hauptbestandteil (WC)

Steigung		Anzahl der Durchgänge	
mm	TPI	60° / 55°	Trapez 30°
0,5	48	6-9	
0,75	32	6-11	
1	24	6-12	
1,25	20	8-14	
1,5	16	9-15	25-50
2	12	11-18	30-70
3	8		45-90

Recommended cutting data

Material group	Composition / structure / heat treatment		Brinell hardness HB	Machining group	Recommended Cutting data Vc [m/min]		
					Uncoated solid carbide HW	PVD coated carbide HC	
					YD201	YPG201	
				Turning feed rate [mm]	Turning feed rate [mm]		
				0,02-0,08	0,02-0,08		
				Grooving feed rate [mm]	Grooving feed rate [mm]		
				0,01-0,03	0,01-0,03		
P	Unalloyed steel	ca. 0,15 % C	annealed	125	1	70	150
		ca. 0,45 % C	annealed	190	2	70	135
		ca. 0,45 % C	tempered	250	3	50	115
		ca. 0,75 % C	annealed	270	4	45	110
		ca. 0,75 % C	tempered	300	5	40	105
	Low-alloyed steel		annealed	180	6	55	135
			tempered	275	7	45	100
			tempered	300	8	40	90
			tempered	350	9	40	85
	High-alloyed steel and high-alloyed tool steel		annealed	200	10		100
		hardened and tempered	325	11		75	
M	Stainless steel	ferritic/martensitic	annealed	200	12		120
		martensitic	tempered	240	13		100
		austenitic	quench hardened	180	14		115
		austenitic-ferritic		230	15		100
K	Grey cast iron	perlitic/ferritic		180	16	55	165
		perlitic (martensitic)		260	17	45	145
	Cast iron with spheroidal graphite	ferritic		160	18	65	175
		perlitic		250	19	50	130
	Malleable cast iron	ferritic		130	20		135
		perlitic		230	21		130
N	Aluminium wrought alloys	cannot be hardened		60	22	200	400
		hardenable	hardened	100	23	150	300
	Cast aluminium alloys	≤ 12% Si, cannot be hardened		75	24	100	200
		≤ 12% Si, hardenable	hardened	90	25	80	160
		> 12% Si, cannot be hardened		130	26	60	120
	Copper and copper alloys (bronze/brass)	machining steel, PB> 1%		110	27	60	120
		CuZn, CuSnZn		90	28	150	300
CuSn, Pb-free copper, electrolytic copper		100	29	60	120		
S	Heat-resistant alloys	Fe-based alloys	annealed	200	30		75
			hardened	280	31		40
		Ni or Co bass	annealed	250	32		60
			hardened	350	33		55
			cast	320	34		55
	Titanium alloys	pure titanium		R _m 400	35		105
α and β alloys		hardened	R _m 1050	36		40	
H	Hardened steel		hardened and tempered	55 HRC	37		
			hardened and tempered	60 HRC	38		
	Hard cast iron		cast	400	39		
	Hardened cast iron		hardened and tempered	55 HRC	40		
X	Non-metallic materials	Thermoplasts			41		
		Thermosetting plastics			42		
		Plastic, glass-fibre reinforced GFRP			43		
		Plastic, carbon fibre reinforced CFRP			44		
		Graphite			45		
		Wood			46		

Note: The given cutting values are guide values, which were determined under ideal conditions. The values have to be adapted in individual cases.

HC Coated carbide
HW Uncoated carbide, main component (WC)

Pitch mm	TPI	Number of passes	
		60° / 55°	Trapeze 30°
0,5	48	6-9	
0,75	32	6-11	
1	24	6-12	
1,25	20	8-14	
1,5	16	9-15	25-50
2	12	11-18	30-70
3	8		45-90

Sonderwerkzeug Formular - *Nonstandard order*

Sonderwerkzeuge - Non Standrad Tool – miniTURN*Solid Carbide*





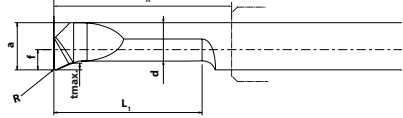
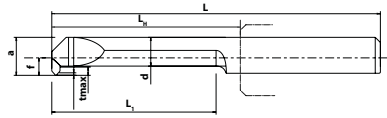
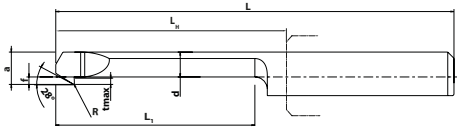
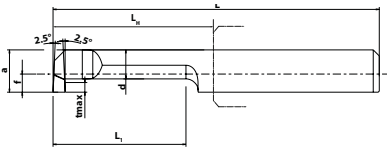
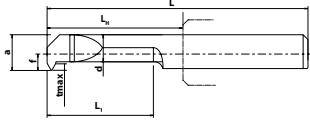
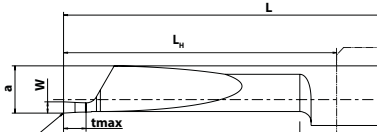







Name/Firma:	 Wanheimer Str. 57 40472 Düsseldorf, Deutschland Fax: +49-(0)211-989240-111 E-Mail: technik@zccct-europe.com sandro.maass@zccct-europe.com
Adresse:	
Tel.:	
Fax:	
E-Mail:	

Material		Beschichtung - Coating	
Werkstoff <i>Material</i>		Ja <input type="checkbox"/> Yes <input type="checkbox"/>	Nein <input type="checkbox"/> No <input type="checkbox"/>
Zugfestigkeit (N/mm ²) Tensilestrength			
Härte <i>Hardness</i>			













Angaben in - Dimensionss in			Material	
D_{h6}	mm		Ausdrehen und Kopieren - <i>Turning and Profiling</i> <input type="checkbox"/> T (T1-T4) 	
D_{min}	mm		Fasen - <i>Chamfering</i> <input type="checkbox"/> C (C1) 	
d₁	mm		Rückwärtsbearbeitung - <i>Back Turning</i> <input type="checkbox"/> B (B1) 	
d₂	mm		Stechdrehen - <i>Grooving</i> <input type="checkbox"/> G (G1-G2) 	
L	mm		Gewindedrehen - <i>Threading</i> <input type="checkbox"/> P (P1-P4) 	
L₁	mm		Axialstechen - <i>Facegrooving</i> <input type="checkbox"/> F (F1-F3) 	
L_H	mm			
R	mm			
t_{max}	mm			
H₁	mm			
H_p	mm			
r	mm			
w	mm			
a	mm			
f	mm			
d	mm			
P	mm			
TPI	mm			
R/L	mm			

Bemerkungen - <i>Comment</i> :	
Auftragsmenge - <i>Quantity</i> :	Gewünschtes Lieferdatum - <i>Requested Delivery Date</i> :
Datum - <i>Date</i> :	Unterschrift - <i>Signature</i> :

Übersicht der Parameter in Abhängigkeit der Anwendung und des Eckenradius R

Anwendung	Vorschub Vf in mm/U	Eckenradius R in mm	Schnitttiefe ap in mm
	0,01 - 0,02	0,03	0,01 - 0,03
	0,01 - 0,03	0,05	0,02 - 0,07
	0,03 - 0,06	0,10	0,05 - 0,15
	0,03 - 0,08	0,15	0,08 - 0,20
	0,04 - 0,12	0,20	0,10 - 0,25
	0,07 - 0,18	0,30	0,15 - 0,35
	0,10 - 0,25	0,40	0,20 - 0,40
	0,01 - 0,03		
			
	0,01 - 0,05		
			
	0,03 - 0,09	0,10	0,05 - 0,15
	0,03 - 0,13	0,15	0,08 - 0,20
	0,04 - 0,17	0,20	0,10 - 0,25
	0,07 - 0,22	0,30	0,15 - 0,35
	0,10 - 0,27	0,40	0,20 - 0,40

Feed rate F and cutting depth a_p in correlation to corner radius R

Application	Feed rate V_f in mm/U	Corner radius R in mm	Depth of cut a_p in mm
	0,01 - 0,02	0,03	0,01 - 0,03
	0,01 - 0,03	0,05	0,02 - 0,07
	0,03 - 0,06	0,10	0,05 - 0,15
	0,03 - 0,08	0,15	0,08 - 0,20
	0,04 - 0,12	0,20	0,10 - 0,25
	0,07 - 0,18	0,30	0,15 - 0,35
	0,10 - 0,25	0,40	0,20 - 0,40
	0,01-0,03		
			
	0,01 - 0,05		
			
	0,03 - 0,09	0,10	0,05 - 0,15
	0,03 - 0,13	0,15	0,08 - 0,20
	0,04 - 0,17	0,20	0,10 - 0,25
	0,07 - 0,22	0,30	0,15 - 0,35
	0,10 - 0,27	0,40	0,20 - 0,40

miniTURN *Solid Carbide*

Produktenerweiterung – Product extension

Wirtschaftliche Zerspantung von kleinen Bauteilen – *Economical machining of small components*

Ab sofort gibt es das miniTURN Ausdrehprogramm von ZCC Cutting Tools Europe als 10-teiliges Set. Die präzisionsgeschliffenen VHM-Werkzeuge wurden speziell für die wirtschaftliche Zerspantung von kleinen Bauteilen entwickelt. Das Sortiment umfasst unterschiedliche Schaftgrößen zwischen 4 – 7 Millimetern und Bearbeitungsdurchmesser von 1 bis 10 Millimetern. Das Miniausdrehprogramm bietet ein großes Anwendungsspektrum vom Profildrehen bis hin zum Axialstechen.

Mit dem von uns zusammengefassten 10-teiligen Set, bieten wir die Möglichkeit ein weites Spektrum der Dreh- und Stechbearbeitungen abzudecken. Überzeugen Sie sich selbst von unserer High Performance Beschichtung YPD201. Das Programm hat sich in unzähligen anspruchsvollen Anwendungsgebieten bewährt.

The new miniTURN boring program from ZCC Cutting Tools Europe is now available as a 10 piece set. The precision-ground solid carbide tools have been specially developed for cost-effective machining of small diameter components. The product range includes different shank sizes from 4 to 7 millimetres and machining diameters of 1 to 10 millimeters. The program offers a wide range of applications from profile turning to axial grooving.

With the 10 piece set we offer the possibility to cover a wide range of turning and boring operations. Convince yourself of our high performance YPD201 coating. The miniTURN program has already proven itself in countless demanding fields of application.





		Abmessungen / Dimensions [mm]						
(Artikel /Article)	Beschreibung /Description	Dh6	Dmin	L1	R	tmax	HC ¹ (PVD)	
T1.4.40.16.020R YPG201	Ausdrehen / Turning	4	4	16	0,20	0,3	YPG201	
T1.5.50.21.020R YPG201	Ausdrehen / Turning	5	5	21	0,20	0,5	YPG201	
T1.6.60.21.020R YPG201	Ausdrehen / Turning	6	6	21	0,20	0,5	YPG201	
(Artikel /Article)	Beschreibung /Description	Dh6	Dmin	L1	W	tmax		
G1.4.40.11.10R YPG201	Stechdrehen / Grooving	4	4	11	1,0	0,8	YPG201	
G1.5.50.21.15R YPG201	Stechdrehen / Grooving	5	5	21	1,5	1,0	YPG201	
G1.5.50.21.20R YPG201	Stechdrehen / Grooving	5	5	21	2,0	1,0	YPG201	
G1.6.60.21.15R YPG201	Stechdrehen / Grooving	6	6	21	1,5	1,8	YPG201	
G1.6.60.21.20R YPG201	Stechdrehen / Grooving	6	6	21	2,0	1,8	YPG201	
(Artikel /Article)	Beschreibung /Description	Dg6	d1	d2	L			
DH1600.4.5	Halter doppelseitig / Double sided holder	16	4	5	80			
DH1600.6.7	Halter doppelseitig / Double sided holder	16	6	7	80			

*Artikelnr. / Article-No.

HC¹ Coated carbide
 HW Uncoated carbide, main component (WC)



Scan for PDF

Mini Turn *Solid Carbide*

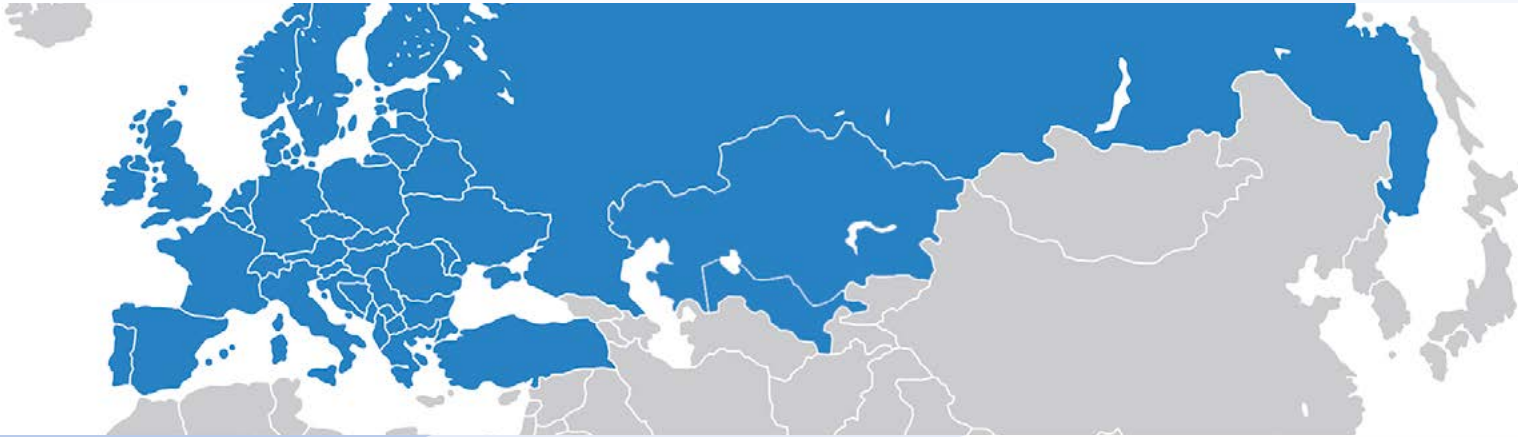

Europe head office
Europazentrale

ZCC Cutting Tools Europe GmbH

www.zccct-europe.com

Wanheimer Str. 57, 40472 Düsseldorf, Germany

Tel.: +49(0)211-989240-0

Fax: +49(0)211-989240-111

E-Mail: info@zccct-europe.com

France branch office
Zweigniederlassung Frankreich

ZCC Cutting Tools Europe GmbH Succursale Française

www.zccct-europe.com

14, Allée Charles Pathé, 18000 Bourges, France

Tél.: +33 (0)2-454101-40

Fax: +33 (0)800 74 27 27

E-Mail: ventes@zccct-europe.com

© Copyright by ZCC Cutting Tools Europe GmbH
All rights reserved. / *Alle Rechte vorbehalten.*

All rights reserved. All descriptions and pictures are protected by copyright. Usage, modification and reproduction, completely or partially, without written permission are prohibited. Subject to technical changes and changes of the delivery program. Mistakes and printing errors are reserved.

Alle Rechte vorbehalten. Alle Beschreibungen und Abbildungen sind urheberrechtlich geschützt. Die Verwendung, Modifikation und Vervielfältigung, ganz oder teilweise, ohne schriftliche Genehmigung sind untersagt. Technische Änderungen und Änderungen des Lieferprogrammes vorbehalten. Für Druckfehler und Irrtümer keine Gewähr.